

Kol. Opis1 **KPC 300 A**

Paznja! Slika proizvoda se može razlikovati od stvarnog proizvoda

Proizvodni broj: [98851053](#)

The KPC 300 and 600 are designed mainly for automatically operated, permanent domestic applications for draining basements and garages, which are subject to flooding.

Thanks to its compact, easy-to-handle design, it can also be used as a portable pump for emergencies such as lifting water from tanks or rivers, emptying swimming pools, fountains, excavations and underpasses.

It is also ideal for gardening and hobbies in general.

The level switch allows permanent installation and guarantees automatic pump operation.

Tečnost:

Raspon temperature tečnosti: 0 .. 35 °C

Gustina: 998.2 kg/m³

Tehnički:

Maximum flow: 3.61 l/s

Type of impeller: POLUOTVORENO

Max. Particle: 10 mm

Materijali:

Kućište pumpe: Kompozitno

Rotor: NORYL GFN2

Motor house: Nerđajući čelik

EN 1.4301

AISI 304

Ugradnja:

Opseg temperature okruženja: 0 .. 35 °C

Izlaz pumpe: RP 1 1/4

Maximum installation depth: 7 m

Installation (Submerged/Dry): SUBMERGED

Elektro podaci:

Power input P1: 350 W

Rated power - P2: 0.22 kW

Frekvencija struje: 50 Hz

Potrebni napon: 1 x 220-240 V

Rated current: 1.5 A

Rated speed: 2900 rpm

Veličina kondenzatora - radni: 8 µF/450 V

Klasa zaštite (IEC 34-5): IP68

Insulation class (IEC 85): F

Thermal protection: INT.

Length of power cable: 10 m

Power plug: SCHUKO



Naziv firme:

Napravio:

Telefon:

Datum: 8.4.2024.

Kol. Opis

1	Ostali:	
	Net weight:	4.1 kg
	Gross weight:	4.6 kg
	Shipping volume:	0.016 m ³
	Country of origin:	CN
	Custom tariff no.:	84137021

98851053 KPC 300 A 50 Hz

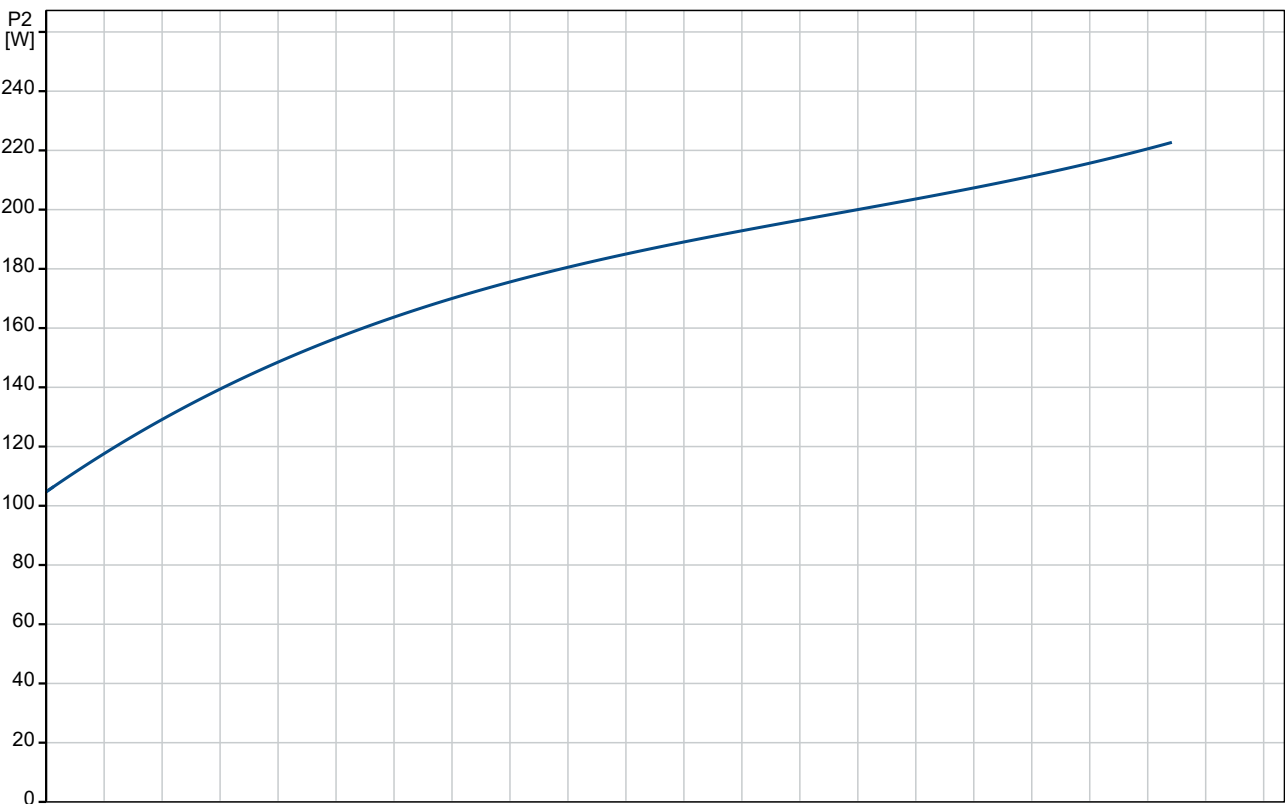
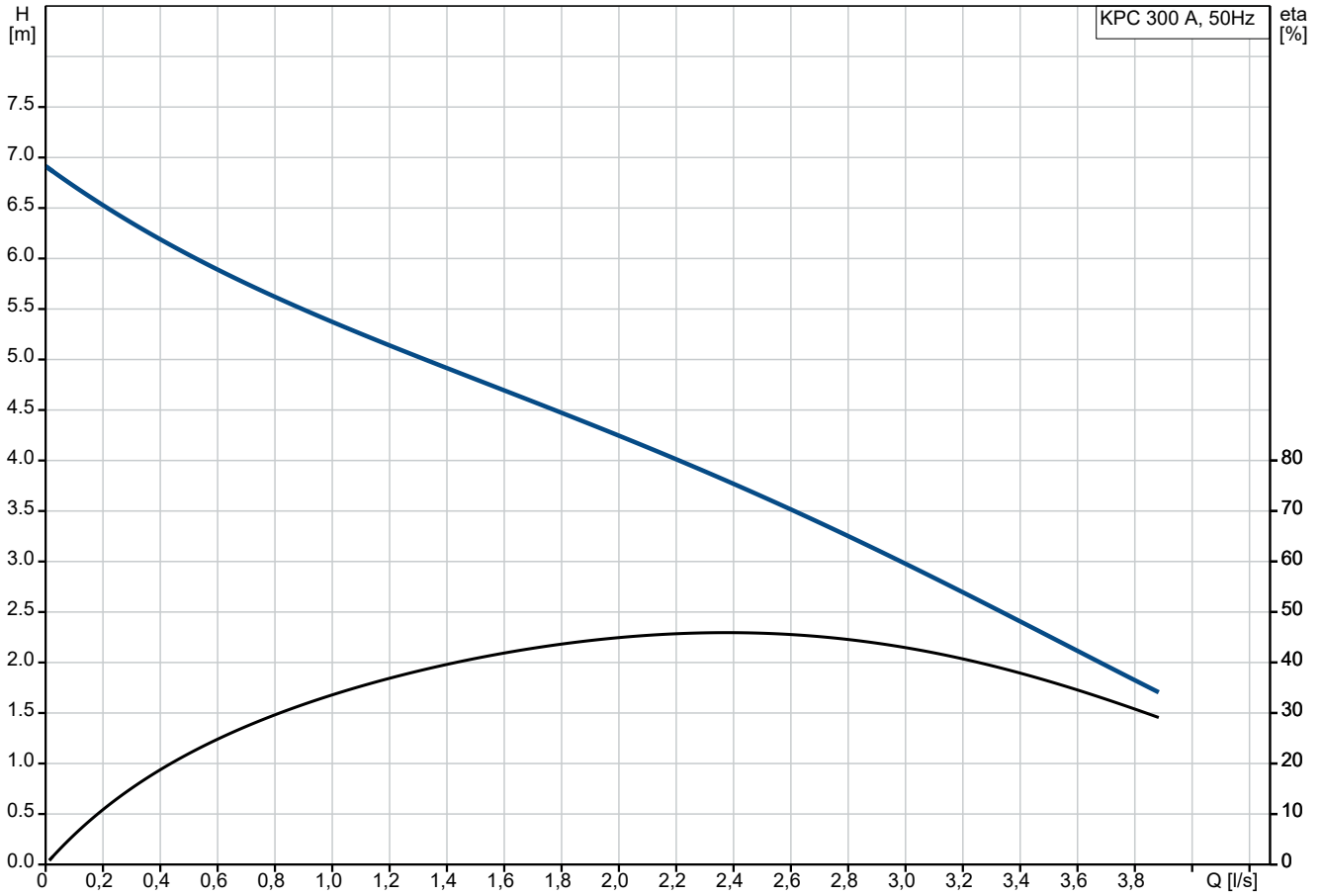

Opis	Vrednost
Opšte informacije:	
Ime proizvoda::	KPC 300 A
Šifra proizvoda:	98851053
EAN broj::	5712602371802
Cena:	€ 173.48
Tehnički:	
Maximum flow:	3.61 l/s
Maximum head:	6.5 m
Type of impeller:	POLUOTVORENO
Max. Particle:	10 mm
Model:	A
Materijali:	
Kućište pumpe:	Kompozitno
Rotor:	NORYL GFN2
Motor house:	Nerđajući čelik
Motor house:	EN 1.4301
Motor house:	AISI 304
Ugradnja:	
Opseg temperature okruženja:	0 .. 35 °C
Izlaz pumpe:	RP 1 1/4
Maximum installation depth:	7 m
Installation (Submerged/Dry):	SUBMERGED
Ugradnja:	Vertical
Tečnost:	
Raspon temperature tečnosti:	0 .. 35 °C
Gustina:	998.2 kg/m ³
Elektro podaci:	
Power input P1:	350 W
Rated power - P2:	0.22 kW
Frekvencija struje:	50 Hz
Potrebni napon:	1 x 220-240 V
Rated current:	1.5 A
Rated speed:	2900 rpm
Veličina kondenzatora - radni:	8 µF/450 V
Klasa zaštite (IEC 34-5):	IP68
Insulation class (IEC 85):	F
Thermal protection:	INT.
Length of power cable:	10 m
Power plug:	SCHUKO
Kontrole:	
Sklopka nivoa:	A/WITH
Ostali:	
Net weight:	4.1 kg
Gross weight:	4.6 kg
Shipping volume:	0.016 m ³
Country of origin:	CN
Custom tariff no.:	84137021

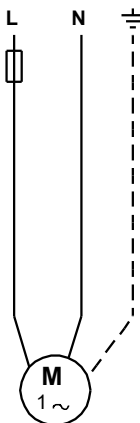
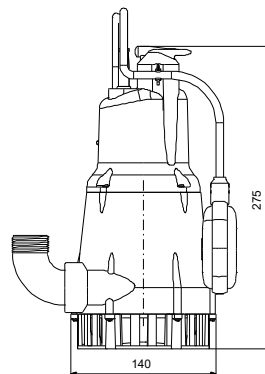
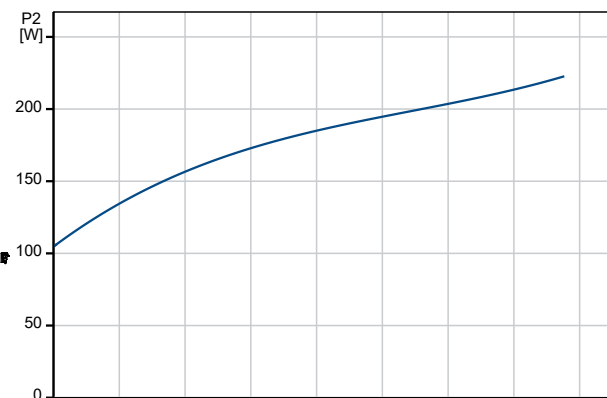
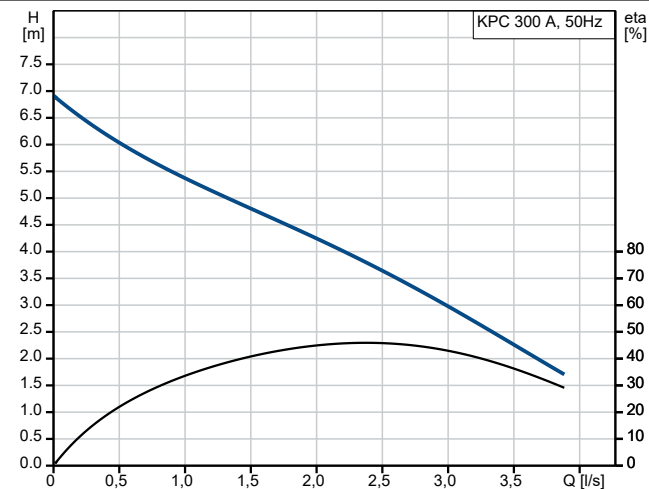

98851053 KPC 300 A 50 Hz

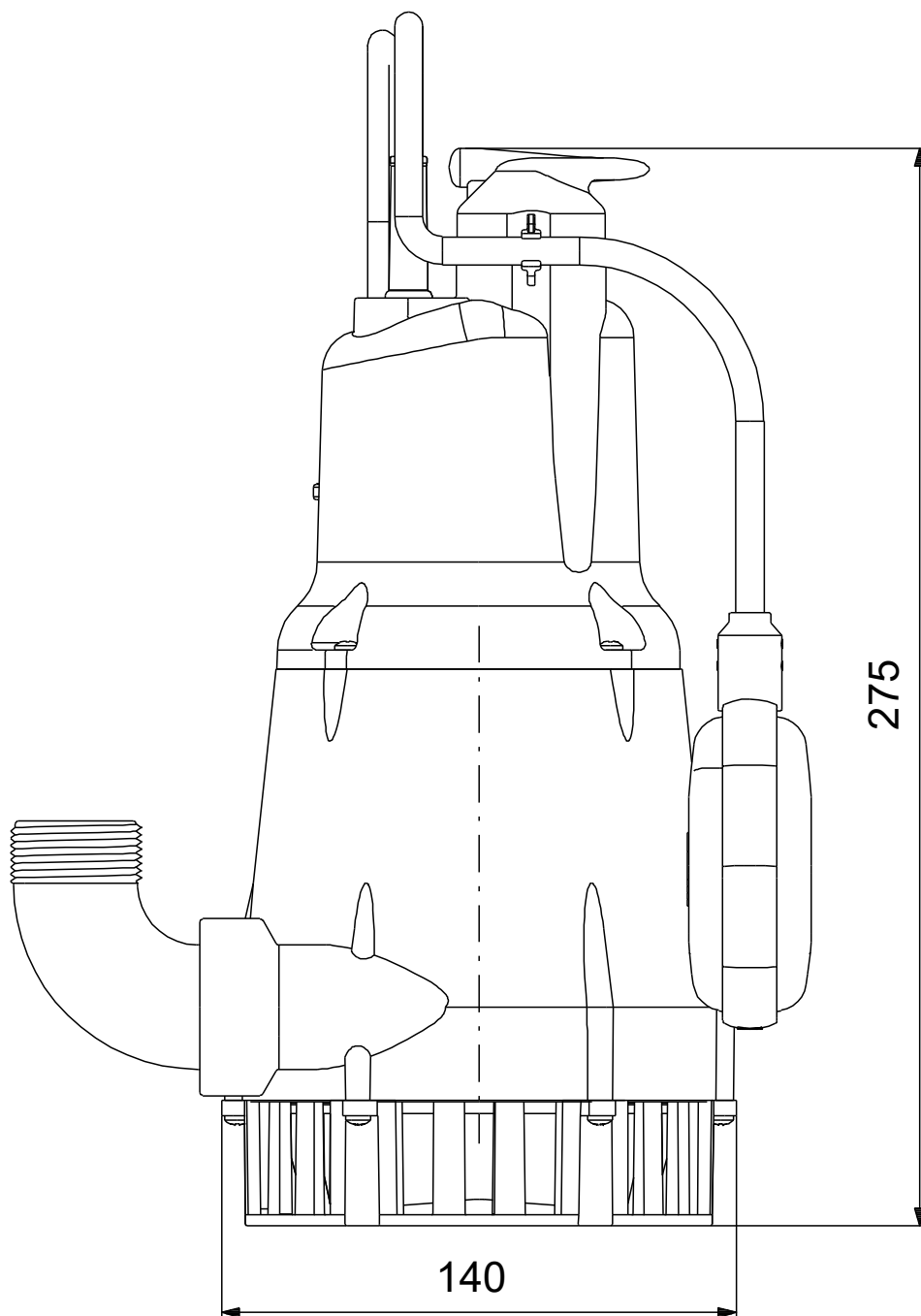

Napomena! Sve jedinice su u [mm]ukoliko drugačije nije navedeno.
Upozorenje: Ovaj pojednostavljeni dimenzioni crtež ne pokazuje sve detalje.